

V5000 Terminal Unit Valves Series

Product Bulletin

PB_V5000
Issue Date 10 2008

The V5000 Valve Series is primarily designed to regulate the flow of water in response to the demand of a controller in zone and terminal unit applications and can be used in combination with VA-7047 and VA-7048 Thermal ON/OFF Actuators, VA-7067 Thermal 0...10 VDC Actuator and VA-747x Electric Actuator Series.

The valves are available in 2-way PDTC (Normally Open), 3-way mixing/diverting and 3-way mixing/diverting with built-in bypass with BSPP and compression fitting body connection.



V5000 Valves

Features and Benefits

Features	Benefits
2-way PDTC (NO) and 3-way configurations	Flexible applications
3-way with built-in bypass configuration	Reduces piping installation time and cost
3-way valves designed for mixing and diverting application	Wide range of application
Forged brass body, stainless steel stem and spring	Ensure long life and it is compact
Rubber compound plug for bubble-tight shut-off	Maximises energy saving
Actuator can be field installed after piping	Simplifies installation in confined location
Commissioning Cap	Easy commissioning and manual operation without actuator
Built-in return spring	Allows the valve to return to normal position when actuator is not mounted or when VA-7047 is de-energised
BSPP and Compression Fitting Body Connection	Flexible applications

Dimensions

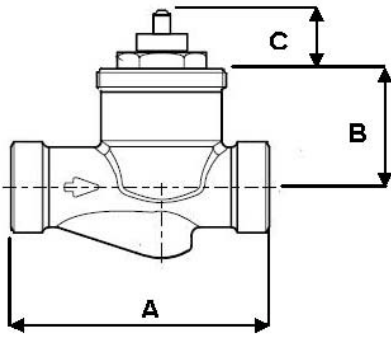

2-way valve

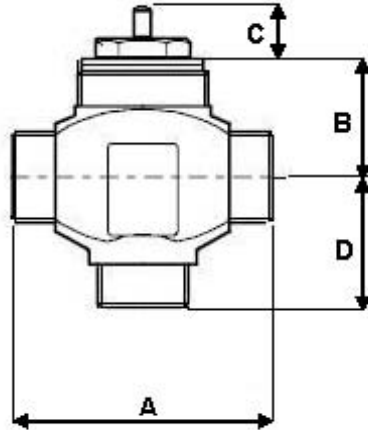

3-way valve

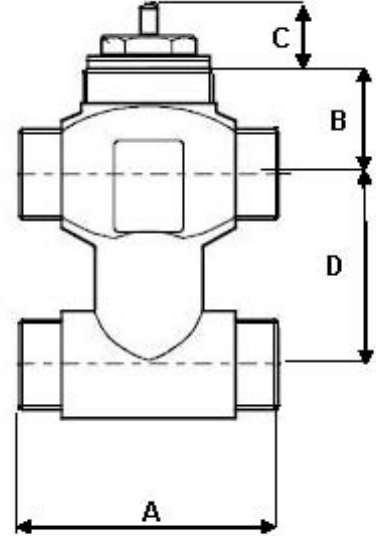

3-way bypass valve

Ordering Codes

Codes	*	Valve Type	Body Size	Kv _s Control Port	Kv _s Bypass Port	Close-Off Pressure (kPa)	Dimensions (mm)			
							A	B	C	D
V5210ZC		2 way	10	0.16	---	400	60	27.5	15.5	---
V52x0BC				0.4						
V52x0CC				0.63						
V52x0DC				1						
V52x0EC			1.6							
V5210JC	*		15	2.5		110	65	33.7		
V5210KC	*			3.5						
V5210MC	*			4.5						
V5810BC		3 way	10	0.4	0.3	120	60	27	15.2	30
V5810CC				0.63	0.4					
V5810DC				1	0.63					
V5810EC				1.6	1					
V5810JC			15	2.5	1.6	150				
V5810KC				4	2.5					
V5810MC				5	3.5		110			
V55x0BC			3 way + BP	10	0.4	0.3	180	60	27	15.2
V55x0CC		0.63			0.4					
V55x0DC		1			0.63					
V55x0EC		1.6			1					
V5510JC	*	15		2.5	1.6	150				
V5510KC	*			4	2.5					
V5510MC	*			5	3.5		110			

x = 1: BSPP

9: Compression Fitting

* = Compression Fitting Kit

available for DN15 and DN20

DN15: 0378145015

DN20: 0378145020

Valve Selection

The valve size for water applications can be defined using the diagrams below.

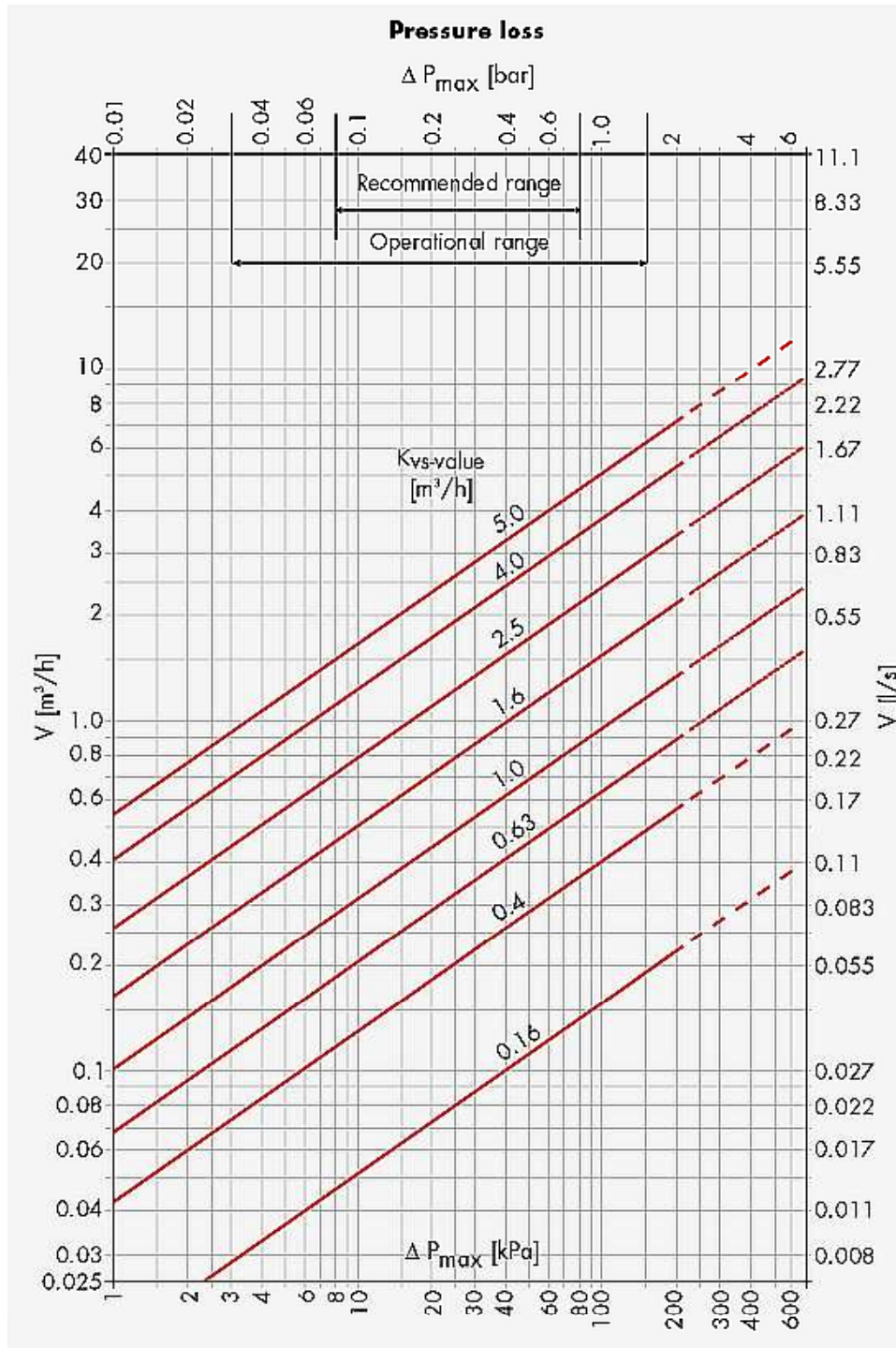

Kvs selection diagram in SI units

Valve - Actuators Combinations

The V5000 series valves are designed to be used with following actuators:









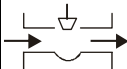

Item code	Action	Supply voltage
VA-7047-21	Direct Acting (stem extends when actuator is energized)	24 VAC / VDC
VA-7048-21	Reverse Acting (stem retracts when actuator is energized)	
VA-7047-23	Direct Acting (stem extends when actuator is energized)	230 VAC / VDC
VA-7048-23	Reverse Acting (stem retracts when actuator is energized)	
VA-7067-21	Stem extends with increasing input signal	24 VAC
VA-7470-1001		
VA-7472-1001		
VA-7472-9001		

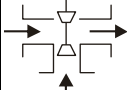
See "VA-704x and VA-706x Thermal Valve Actuators" and "VA-747x Electric Actuators" Product Bulletins for more information.

Operation

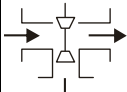
These valves are used for hot or cold water and for water glycol mixtures up to 50%.

Note: These valves are intended to control equipment under normal operating conditions. Where failure or malfunction of the valves could lead to an abnormal operating condition that could cause personal injury or damage to the equipment or other property, other devices (limit or safety controls) or systems (alarm or supervisory systems) intended to warn of or protect against failure or malfunction of the valves must be incorporated into and maintained as part of the control system.

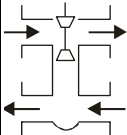
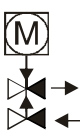
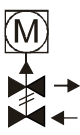
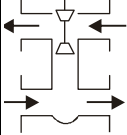
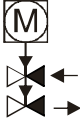
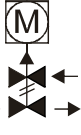
Valve Type	Stem Movement / Flow	
	Actuator Stem down	Actuator Stem up
 2-Way PDTC (NO)		
 3-Way MIXING 		
 3-Way DIVERTING 		
 3-Way + bypass RETURN SUPPLY		
 3-Way + bypass SUPPLY RETURN		

Mounting Instructions

General Guidelines

In addition to general installation instructions, please observe the following points:

- Ensure that valve body and piping are free of impurities.
- Pay attention to position of the valve relative to the flow direction.
- Note arrows on valve body.
- Ensure that threaded connections of valve and piping are tightened.
- Ensure installation without tension and torque.
- Do not use the valve as a step or fixation point. Only piping supports it.
- Protect valve from dust or dirt on construction sites.
- Provide strainer or filter upstream of valve.
- Use compensators to balance thermal expansion of piping.
- Ensure that stem thread and shaft are kept free of paint.

Installation Site Information

The valve installation site should be easily accessible and provide sufficient room for service and removal of actuators. Manual shut-off valves should be located up and downstream of the control valve, to facilitate service and repairs without drainage of the piping system. The control valve should preferably be installed in vertical or horizontal position.

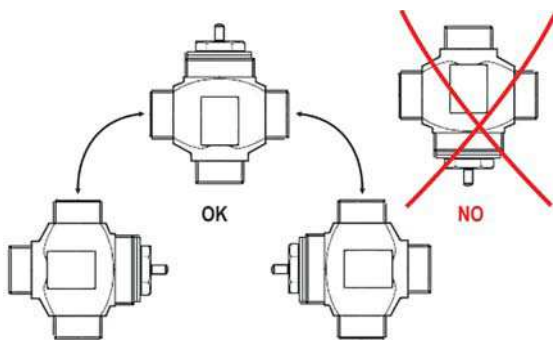

Piping should be insulated to protect actuators against high temperatures. Insulation should leave sufficient room for service of stem packing. To ensure trouble free function of the control valves the pipe immediately upstream of the valve should be straight for the length of at least 2x DN and the pipe immediately downstream straight for the length at least 6x DN.

Commissioning

Prior to commissioning check information on material, pressure, temperature and flow direction in conjunction with the installation piping system plan. Impurities in the piping system and valves, such as dirt, welding beads etc. will cause the system to leak. Prior to commissioning a new installation or re-commissioning after repairs or service, ensure that:

- Correct installation and assembly work has been completed.
- Only qualified personnel carry out commissioning.
- Correct functional position of the valve is ascertained.
- Maintenance of existing protective facilities is carried out.

Valve Removal

In addition to general guidelines the following points should be observed:

- Pressure free piping system
- Cooled fluid
- Drained piping system
- With corrosive or aggressive fluids, the piping system should be vented.

Work to be performed by qualified personnel only.

Technical Specifications

Products		V5000		
Models	V5210	V5810	V5510	
Body Type	2-way PDTC (NO)	3-way mixing/diverting	3-way mixing diverting with built-in bypass	
Body Rating	PN16 Nominal, maximum rated pressure			
Inherent Flow Characteristic	Equal percentage			
Rangeability	50:1 (control port)			
Service	Water, glycol solutions (max 50%) for HVAC applications. Fluid Group 1 according 67/548/EEC. (proper water treatment is recommended, refer to VDI 2035)			
Body Size (according ANSI B36.10)	DN10 DN15 DN20			
Max Pressure drop Δp	DN10: 380 kPa DN15: 110 kPa DN20: 110 kPa	DN10: 170 kPa DN15: 140 kPa DN20: 100 kPa		
Kv _s and max. close-off pressure	See "Ordering Code and Dimensions" on page 2			
Body Connecticus	Gas BSP Parallel (ISO 228/1, BS 2779, DIN 259); Compression fitting (EN1254-2)			
Nominal Stroke	4 mm	3.7 mm		
Connection to Actuator	M30 x 1.5			
Materials				
Valve body and seat:	DN10: Cu Zn 40 Pb2 as per EN12164 DN15 and DN20: Cu Sn 3 Zn 8 Pb5-C as per EN1982	Cu Zn 39 Pb 1 Al-C as per EN1982		
Spindle:	X10 Cr Ni18-8 as per EN188-1	X8 Cr Ni S 18-9 as per EN188-1		
Plug and stuffing box:	Cu Zn 40 Pb2 as per EN12164	Cu Zn 40 Pb 2 as per EN12164		
Leakage	Max 0,01% of KVS, Class IV for ANSI FCI 70-2 and EN60534-4 modif. 1			
Fluid Temperature Limits	0...120 °C			
Ambient Temperature Limits	2...50 °C			
Max weight packaging excluded	2-way NO	3-way mixing / diverting	3 way mixing / diverting + built-in bypass	
DN10	180 g	300 g	380 g	
DN15	280 g	330 g	420 g	
DN20	330 g	360 g	500 g	
Compliance	PED (Pressure Equipment Directive) 23/97/CE (Paragraph 3, comma 3) CE marking is not applicable. ROHS			

The performance specifications are nominal and conform to acceptable industry standards. For application at conditions beyond these specifications, consult the local Johnson Controls office. Johnson Controls, Inc. shall not be liable for damages resulting from misapplication or misuse of its products.

Johnson Controls International, Inc.

Headquarters: Milwaukee, Wisconsin, USA

Branch Offices: Principal Cities World-wide

